

Name: \_\_\_\_\_

Ready to make equations? There is a missing equation in each box.  
Circle the numbers once you find it!

**A**

27	<b>25</b>	59
-	40	94 37
	51	69 47

Find a subtraction fact.

**B**

78	1	28
+	33	27 11
	9	71 54

Find an addition fact.

**C**

55	77	62
-	84	42 28
	57	86 31

Find a subtraction fact.

Equations:

Write the equation facts you found.

<b>A</b>		-		=	<b>25</b>
<b>B</b>		+		=	
<b>C</b>		-		=	

Convert to a fraction or mixed number and simplify.

5.05698 =

0.00976 =

61.00064 =

0.86634 =

4.0003 =

1.0535 =

$6868 + 262 + 598 =$

Reduce each fraction to a mixed numeral in its lowest terms.

$\frac{306}{54} =$

$\frac{108}{54} =$

$\frac{4}{12} =$

$\frac{120}{72} =$

$\frac{4}{16} =$

$\frac{196}{63} =$

Name: \_\_\_\_\_

Cross off the letter that does NOT belong.

C, J, D, K, E, F, L, F, M, G, N, H, O, I, P

Why does \_\_\_\_\_ not belong in the pattern?

Cross off the number that does NOT belong.

(4,096), (1,024), (256), (204),

(64), (16), (4), (1),

$\frac{1}{4}$  ,  $\frac{1}{16}$  ,  $\frac{1}{64}$

Why does \_\_\_\_\_ not belong in the pattern?

Name: \_\_\_\_\_

Nathan wanted to make a poster for Save Your Smile Week. He thought it would be fun to put how many minutes someone might spend brushing and flossing each year on the poster. If a person spends 19 minutes per day brushing and flossing, how long would that person spend in a year? (Use 365 days for one year.)

David works at Jeans and Things, which sells 7 different sizes of boys' Levis. His job is to keep the shelves stocked. The display of boys' Levis should have 10 pairs on it at the beginning of the day. After a sale on Monday, only one-fifth of the jeans were left on the display. How many pairs of jeans will David have to replace on the display?

Megan is mapping an imaginary trip from point  $(-7, 7)$  to  $(4, 7)$ . She liked  $(4, 7)$  so much that she was there for 8 days! Then she went to visit point  $(4, 4)$ . Aren't you jealous? If 1 unit = 100 miles, how many total miles did she travel?

Rewrite this mixed number as an improper fraction.

$$14 \frac{9}{10}$$



Name: \_\_\_\_\_

Ready for a challenge? See how long this takes.

My starting time: \_\_\_\_\_ : \_\_\_\_\_ and \_\_\_\_\_ seconds.

My ending time: \_\_\_\_\_ : \_\_\_\_\_ and \_\_\_\_\_ seconds.

Find the LCM using the Birthday Cake method.

9	198   180
2	22   20
	11   10
LCM: $9 \times 2 \times 11 \times 10 = 1980$	

3	27   15
LCM: _____	



2	30   60
LCM: _____	

4	48   60
LCM: _____	

2	28   48
LCM: _____	

55	40
LCM: _____	

72	24
LCM: _____	

20	14
LCM: _____	



Name: \_\_\_\_\_

Ready for a challenge? See how long this takes.

My starting time: \_\_\_\_\_ : \_\_\_\_\_ and \_\_\_\_\_ seconds.

My ending time: \_\_\_\_\_ : \_\_\_\_\_ and \_\_\_\_\_ seconds.

Find the LCM using the Birthday Cake method.

<div style="border: 1px solid black; padding: 5px; margin-bottom: 5px;">2   36   48</div> <div style="border: 1px solid black; padding: 5px; margin-bottom: 5px;">2   18   24</div> <div style="border: 1px solid black; padding: 5px; margin-bottom: 5px;">3   9   12</div> <div style="border: 1px solid black; padding: 5px;">3   3   4</div> <p>LCM: <math>4 \times 3 \times 3 \times 4 = 144</math></p>	<div style="border: 1px solid black; padding: 5px; margin-bottom: 5px;">2   48   80</div> <div style="border: 1px solid black; padding: 5px; margin-bottom: 5px;">4   24   40</div> <div style="border: 1px solid black; padding: 5px;">2   6   10</div> <p>LCM: _____</p>
--	--

<div style="border: 1px solid black; padding: 5px; margin-bottom: 5px;">4   32   28</div> <p>LCM: _____</p>	<div style="border: 1px solid black; padding: 5px; margin-bottom: 5px;">3   66   54</div> <p>LCM: _____</p>	<div style="border: 1px solid black; padding: 5px; margin-bottom: 5px;">5   80   120</div> <p>LCM: _____</p>
---	---	--

<div style="border: 1px solid black; padding: 5px; margin-bottom: 5px;">102   54</div> <p>LCM: _____</p>	<div style="border: 1px solid black; padding: 5px; margin-bottom: 5px;">156   228</div> <p>LCM: _____</p>
--	---

Name: \_\_\_\_\_

$10 \times 4 = \underline{\hspace{2cm}}$	How many feet are in 36 inches?  _____ feet	$30 \div 6 = \underline{\hspace{2cm}}$
--	---	--

<p>Rose rolls two dice. She adds the numbers on the two dice. What is the chance of this sum being twelve?</p>	<p>You are given three cards. One card has the number 3 on it, another card has a 9, and the last card has the number 5 on it. Use two cards to make a fraction. What is the smallest fraction that you can make?</p>	$\begin{array}{r} 385 \\ + 347 \\ \hline \end{array}$
		$\begin{array}{r} 928 \\ - 359 \\ \hline \end{array}$

<p>Circle the smallest number:</p> <p>5,380,674,219    439,801</p> <p>5,726            358,601,492</p>	$132 \div 11 = \underline{\hspace{2cm}}$	$\begin{array}{r} 45 \\ + 36 \\ \hline \end{array}$
--	--	---

<p>Here is a pattern of letters:</p> <p style="text-align: center;">X F F X A X F F X A X F F X A X F F ...</p> <p>What letter will be the 44th term in the pattern?</p>	<p>Rewrite these in increasing order of length:</p> <p>245 cm, 960 m, 4 mm, 62 dm</p>
--	---

$5,622 + 9,515 = \underline{\hspace{2cm}}$	<p>What number is halfway between 17 and 31?</p>	$\begin{array}{r} 44 \\ - 27 \\ \hline \end{array}$
--	--	---

Name: \_\_\_\_\_

Circle the addition property for $55 + 8 = 8 + 55$ .  commutative property associative property	The boys in your class each were given a ticket with a number on it. The numbers given out were: 13, 2, 8, 21, 34, 16, 14, 17, 19, and 33. One ticket will be picked from a hat. What are the chances that the winning ticket number is divisible by 6?
$12 \div 6 = \underline{\hspace{2cm}}$	

$7 \times 7 = \underline{\hspace{2cm}}$	1 kg = 1,000 g 26 kg = $\underline{\hspace{2cm}}$ g	$12 \times 8 = \underline{\hspace{2cm}}$
---	--	--

$33 \div 11 = \underline{\hspace{2cm}}$	28 km = $\underline{\hspace{2cm}}$ m	$729 - 617 = \underline{\hspace{2cm}}$
---	--------------------------------------	--

Emily told Anna that she multiplied two consecutive whole numbers and the answer is 90. Anna doesn't believe that is possible. She thinks Emily must have multiplied wrong. Who is correct?	$10 \times 6 = \underline{\hspace{2cm}}$	$10 \times 11 = \underline{\hspace{2cm}}$
---	--	---

$5,784 - 3,175 = \underline{\hspace{2cm}}$

$20 \div 5 = \underline{\hspace{2cm}}$	$8,993 + 6,731 = \underline{\hspace{2cm}}$
--	--

Name: \_\_\_\_\_

### What Words? Your Words!

Fill in the boxes with letters to make words. Each box is worth points. Earn points by filling in as many boxes as you can. Sum up the points you earn for each word.

Once you use a letter, cross it off on the bottom. You cannot use the same letter more than once.

Make a Word	Sum																	
<table border="1"> <tr> <td></td><td></td><td>1</td><td>2</td><td>6</td><td></td> </tr> <tr> <td>I</td><td>N</td><td>C</td><td>H</td><td></td><td></td> </tr> </table>			1	2	6		I	N	C	H			<table border="1"> <tr> <td>3</td> </tr> </table>	3				
		1	2	6														
I	N	C	H															
3																		
<table border="1"> <tr> <td></td><td>1</td><td>2</td><td></td><td>4</td><td>6</td><td>10</td><td>16</td> </tr> <tr> <td></td><td></td><td>E</td><td></td><td></td><td></td><td></td><td></td> </tr> </table>		1	2		4	6	10	16			E						<table border="1"> <tr> <td></td> </tr> </table>	
	1	2		4	6	10	16											
		E																
<table border="1"> <tr> <td></td><td></td><td>1</td><td>2</td><td>6</td><td>10</td><td>16</td> </tr> <tr> <td>B</td><td>O</td><td></td><td></td><td></td><td></td><td></td> </tr> </table>			1	2	6	10	16	B	O						<table border="1"> <tr> <td></td> </tr> </table>			
		1	2	6	10	16												
B	O																	
<p>A <del>X</del> <del>X</del> D <del>X</del> F G <del>X</del> <del>X</del> J K L M  <del>X</del> <del>X</del> P Q R S T U V W X Y Z</p>																		

Make a Word	Sum																	
<table border="1"> <tr> <td></td><td></td><td>1</td><td>2</td><td>6</td><td>10</td><td>16</td><td>22</td> </tr> <tr> <td>D</td><td>E</td><td></td><td></td><td></td><td></td><td></td><td></td> </tr> </table>			1	2	6	10	16	22	D	E							<table border="1"> <tr> <td></td> </tr> </table>	
		1	2	6	10	16	22											
D	E																	
<table border="1"> <tr> <td></td><td></td><td>1</td><td>2</td><td>6</td><td>10</td> </tr> <tr> <td>H</td><td>A</td><td></td><td></td><td></td><td></td> </tr> </table>			1	2	6	10	H	A					<table border="1"> <tr> <td></td> </tr> </table>					
		1	2	6	10													
H	A																	
<table border="1"> <tr> <td></td><td></td><td>1</td><td>2</td><td>4</td><td>8</td> </tr> <tr> <td>R</td><td>U</td><td></td><td></td><td></td><td></td> </tr> </table>			1	2	4	8	R	U					<table border="1"> <tr> <td></td> </tr> </table>					
		1	2	4	8													
R	U																	
<p><del>X</del> B C <del>X</del> <del>X</del> F G <del>X</del> I J K L M  N O P Q <del>X</del> S T <del>X</del> V W X Y Z</p>																		

In the number 686,070,781,207, the digit 1 is in what place?  
 \_\_\_\_\_

$20 \div 2 = \underline{\hspace{2cm}}$

$15 \div 3 = \underline{\hspace{2cm}}$        $80 \div 8 = \underline{\hspace{2cm}}$

Circle the digit in the tenths place.  
 7,442.74

What should replace the S in this equation?  
 $S - 40 + 28 = 30$

What number is halfway between 8 and 18?

$88 \div 8 = \underline{\hspace{2cm}}$

Name: \_\_\_\_\_

9 • 2 • 8 • 0 • ÷ • x • 3 • ÷ • 3 • = • 1 • 0 • 8 • x • 3 • 1 • 4  
7 • 5 • 6

Use the pieces above to help you fill in the runaway math puzzle.

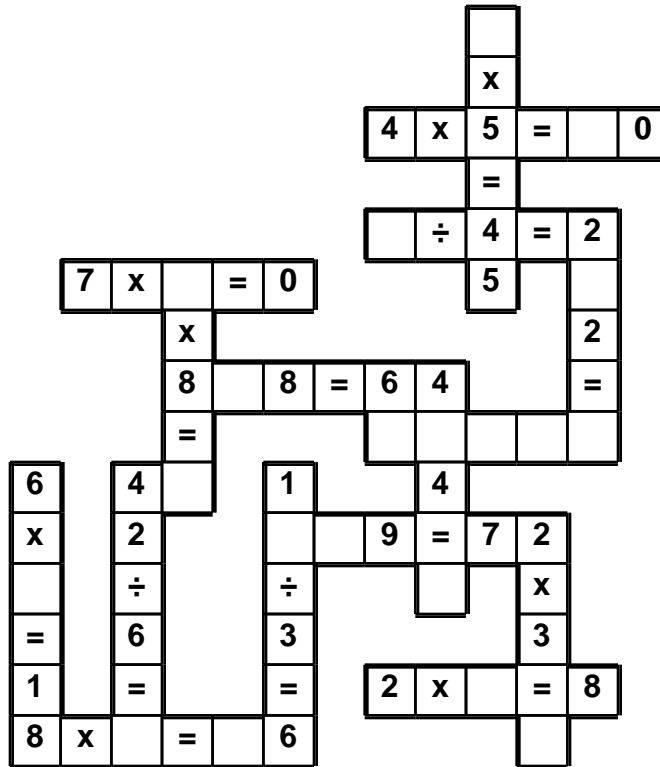

$8,476 + 3,556 =$  \_\_\_\_\_

Can 486 be evenly divided by 7? Circle:  
486 is evenly divisible by 7  
486 is NOT evenly divisible by 7

$12 \times 2 =$  \_\_\_\_\_

$80 \div 10 =$  \_\_\_\_\_

Name: \_\_\_\_\_

Decimal	Percentage
0.8	80%
0.73	
	2%
0.24	
0.32	
	82%

Decimal	Fraction
0.7	
0.07	
0.71	
	$\frac{18}{100}$

Percentage	Fraction
40%	
70%	
	$\frac{15}{100}$
	$\frac{25}{100}$

Fraction	Percentage
$\frac{85}{100}$	
$\frac{60}{100}$	
$\frac{50}{100}$	
$\frac{30}{100}$	

What is the value of m?

$$9m + 14 - 3m = -8$$

In what quadrant would you find the point (-3, -17)?

$$4 + (49 \div 7) - 40 \div 8 =$$

Name: \_\_\_\_\_

$$\begin{array}{r} 2\frac{3}{8} \\ \frac{7}{8} \\ + 8\frac{7}{8} \\ \hline \end{array}$$

$$\begin{array}{r} 655.2 \\ 35.32 \\ 242.9 \\ 67.529 \\ + \underline{3.911} \end{array}$$

142 is what percent of 284?

Write the decimal in words.  
 11.00016

Change 6% to a decimal  
 and a fraction expressed in  
 its lowest terms.

Change  $\frac{12}{25}$  to a  
 decimal.

$$\begin{array}{r} 41,948 \\ - \underline{3,139} \end{array}$$

Write the decimal number  
 for:  
 three hundred thirty-nine  
 and seventy-nine thousand,  
 three hundred seventeen

Change to percents.

$$\begin{array}{l} \frac{29}{100} = \\ \frac{62}{100} = \\ \frac{9}{10} = \\ \frac{90}{100} = \\ \frac{1}{10} = \\ \frac{75}{100} = \end{array}$$

Name: \_\_\_\_\_

The block above is the sum of the two blocks below. Fill in the missing blocks.

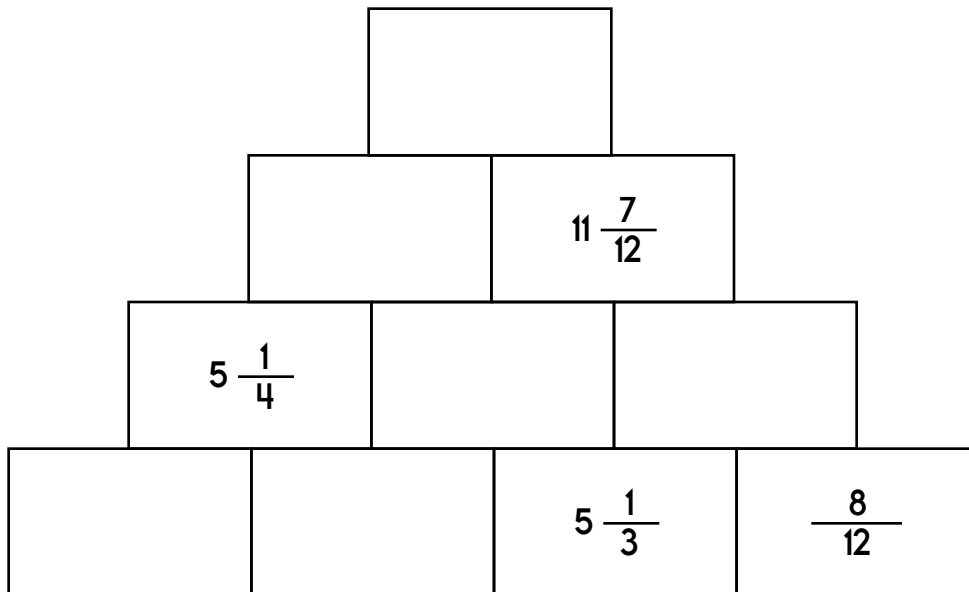
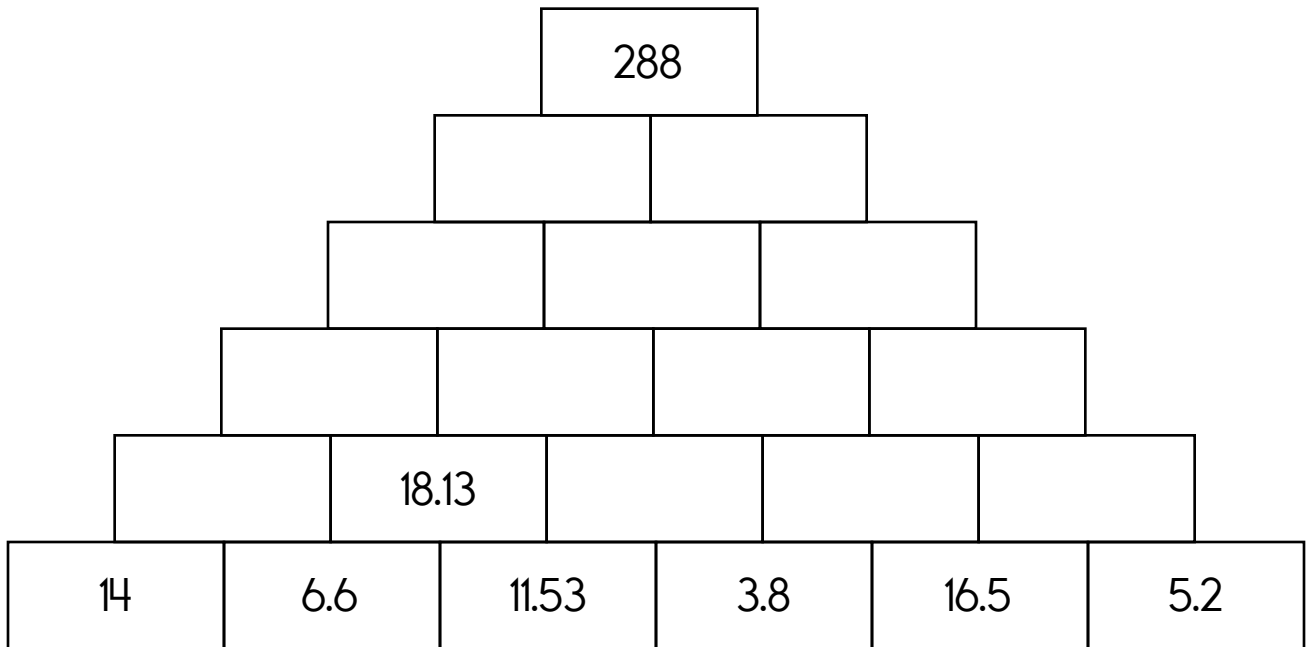

$12 \div 6 =$ _____	$49,461 - 31,134 =$ _____
$558 + 561 =$ _____	$6,277 - 3,867 =$ _____

Name: \_\_\_\_\_

Some vowels are missing in the word search.  
Fill in the missing vowels and circle the words.

N W Z S  V S Z M N  
 Q  I C N R  E  D  
 O N W  V O N R C   
 T D M   C T O K R  
   N T   S F   
 R S C  N   R T  
 R F C  T S I L    
 F  L N   L V    
 N L  R  S A  T N  
 I N S U N T T R M I

TOUR • FRUIT • SCIENCE • SILVER  
 UNTIE • ZERO • MUSCLE  
 WONDERFUL • INVITATION  
 DURATION • CONSIST • MOCK

Some vowels are missing in the word search.  
Fill in the missing vowels and circle the words.

E F C   S  N D U  
 S  S T   N D    
 I A T C R  D  C P  
 C E F F O R T A  T  
 L L  X C  P T D   
 N H  B  T S  M  
 P  R T   L D F   
 T  M P  S T   S  
 S  T  S F Y   T  
 S  M P L  E D D E

PARTIAL • EFFORT • DECADE  
 OPTIMIST • SIMPLE • INHABIT  
 DEAD • FEUD • CRUDE • SUSTAIN  
 EXCEPT • SATISFY • COUSIN  
 TEMPEST

Write the hidden word. Start at one letter and then move either left or right. Continue in same direction.

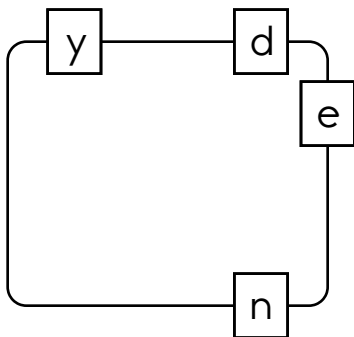

\_\_\_\_\_

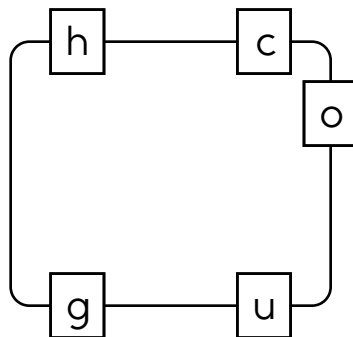

\_\_\_\_\_

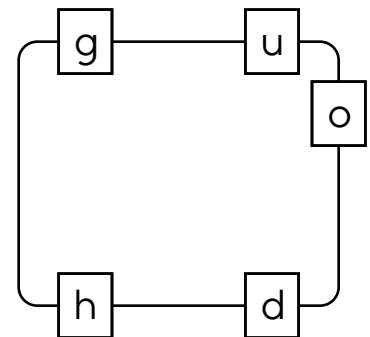

\_\_\_\_\_

Name: \_\_\_\_\_

Draw 3 pictures in the correct order. Use each of the clues so you will know what to draw.

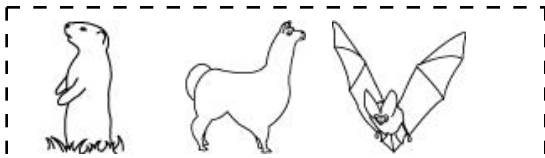

! Draw 1 of these 3 pictures.  
! The picture is NOT in the correct spot.

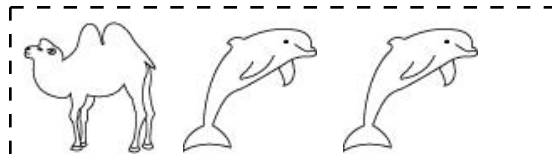

! Draw 1 of these 3 pictures.  
! The picture IS in the correct spot.



! Draw 1 of these 3 pictures.  
! The picture IS in the correct spot.



! Draw 1 of these 3 pictures.  
! The picture IS in the correct spot.

Draw the 3 pictures in the correct order:

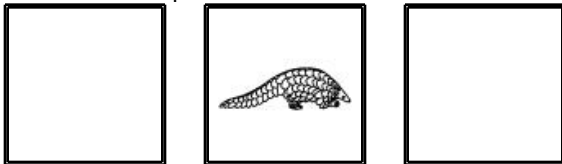

Draw 4 pictures in the correct order. Use each of the clues so you will know what to draw.

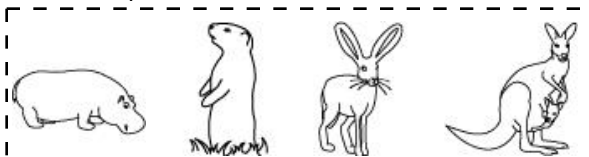

! Draw 1 of these 4 pictures.  
! The picture IS in the correct spot.

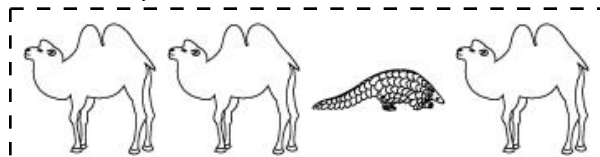

! Draw 1 of these 4 pictures.  
! The picture IS in the correct spot.

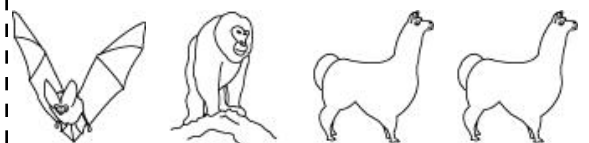

! Draw 1 of these 4 pictures.  
! The picture IS in the correct spot.

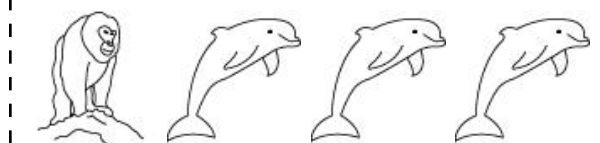

! Draw 1 of these 4 pictures.  
! The picture IS in the correct spot.



! Draw 1 of these 4 pictures.  
! The picture is NOT in the correct spot.

Draw the 4 pictures in the correct order:

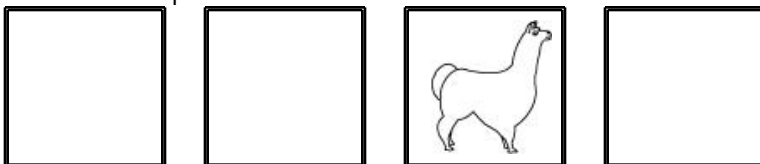

Name: \_\_\_\_\_

Circle words to the RIGHT or DOWN. When you are done, use the letters that are left to find a mystery word. Put a square around each letter left over. The first 2 letters that do not form a word are rectangled.

M U S I C I N S O L E N C E B  
T C C A D O L E S C E N C E U  
H R O E R B R I L L I A N T R  
E E N R I H D E S O L A T E S  
R D D R O A I L A N T E R N A  
I U E B T Y I L L U S I O N R  
T L M S I M U L T A N E O U S  
A I N L L I T A N Y D W A R F  
G T C H R O N O L O G I C A L  
E Y E S L Y A U T H E N T I C

Write the words found.

_____	_____
_____	_____
_____	_____
_____	_____
_____	_____
_____	_____
_____	_____
_____	_____
_____	_____
_____	_____

The secret word is all that is left. It consists of all the letters that did not form a word. What is it?

T	E						
---	---	--	--	--	--	--	--

Using the words from the puzzle, write a different word on each line. Explain what it means.

1. \_\_\_\_\_
2. \_\_\_\_\_
3. \_\_\_\_\_

# Subscribe to Get Answer Keys

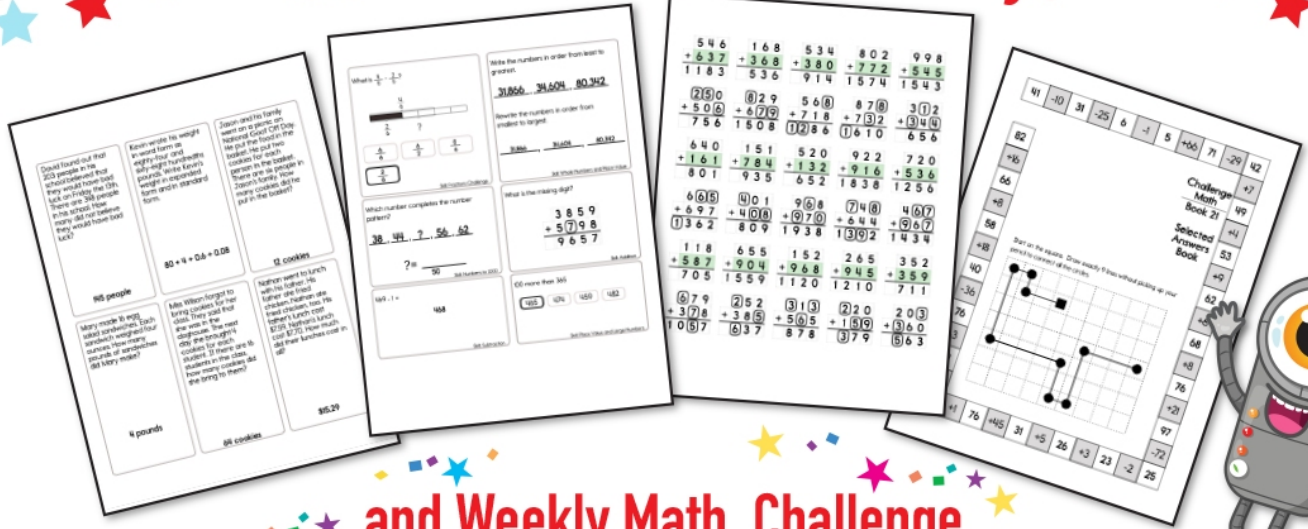

and Weekly Math, Challenge  
Workbooks, Posters, Daily Reading,  
and so much more!

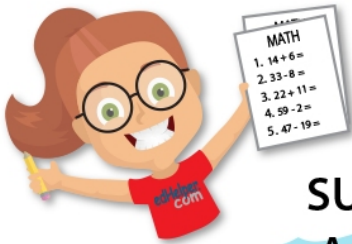

**MATH**  
1.  $14 + 6 =$   
2.  $33 - 8 =$   
3.  $22 + 11 =$   
4.  $59 - 2 =$   
5.  $47 - 19 =$



**ANSWER KEY**  
1.  $14 + 6 = 20$   
2.  $33 - 8 = 25$   
3.  $22 + 11 = 33$   
4.  $59 - 2 = 57$   
5.  $47 - 19 = 28$

**SUBSCRIBE TO RECEIVE EVEN MORE**  
Answer Keys • Effective Activities • Access  
to as many printables as you need!

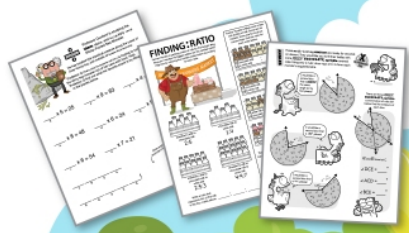

**edHelper.com**

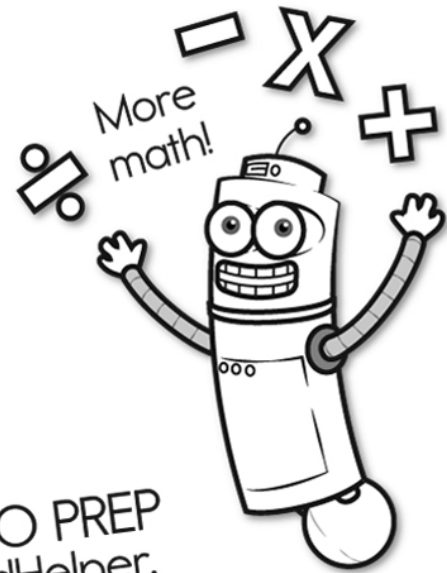
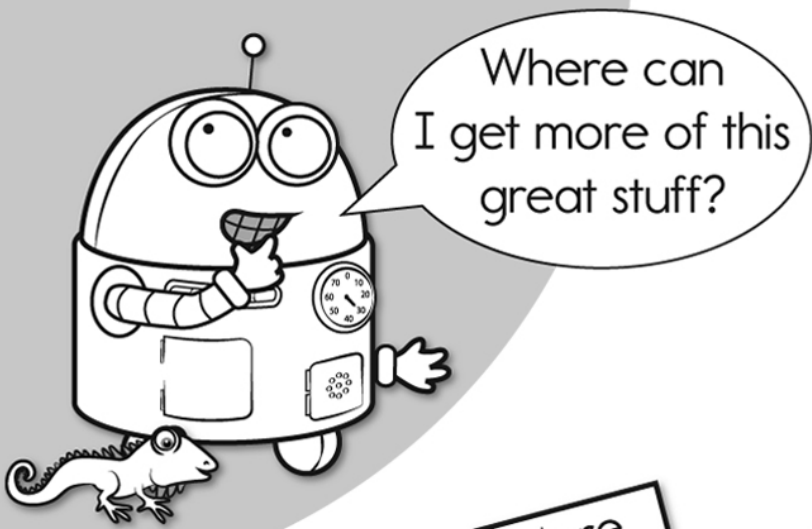

It's NO PREP at edHelper.

More history!



# edHelper.com!

New online math games!

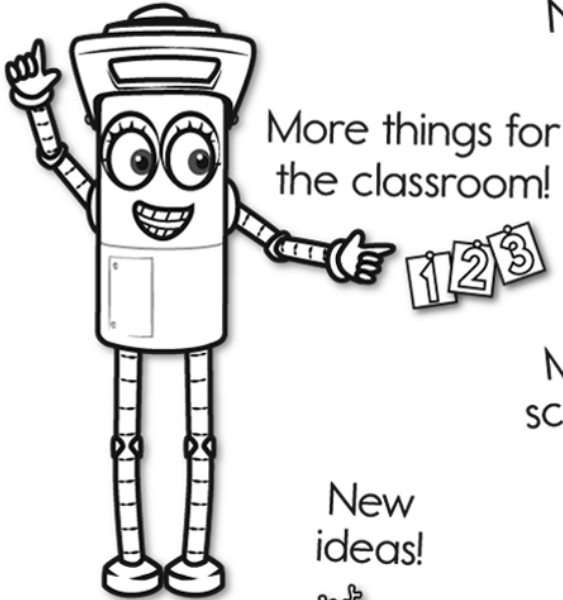
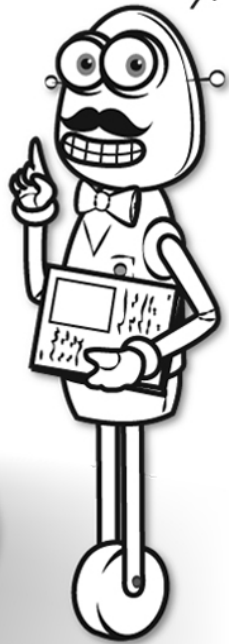

More things for the classroom!

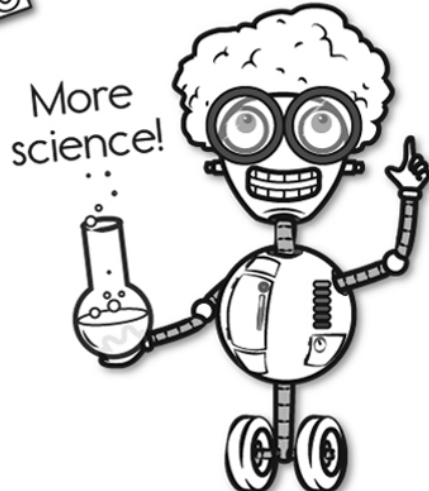

New ideas!

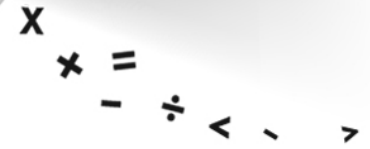

More puzzles!

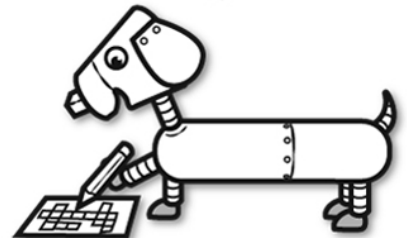

# Take The Boring Out Of Homework!

Easy to  
print!

edHelper

## Weekly K-6 "Take It Home" Books

Kids want choices  
for homework.  
"Take It Home" books  
have fun graphics and  
challenging puzzles and  
problems for older kids.

"Dr. Programmer"  
challenges kids..

Homework  
will never be  
the same!

edHelper.com

